

# SmartPower Stacks™ Spec Sheet

## Level 1: 100 kW DC-AC Inverter

**Model Number:** SPS045B3DA120E

### Key Data

3 Phase Inverter Configuration

Rated output: 100kW

### General Information

Standard configuration includes: (3) IGBT Modules, (3) Gate Drive Boards, (3) Current Sensors, Interface Board & Heat Sink

<b>Topology</b>	3 Phase Inverter (B6I)
<b>Application / Modulation</b>	Inverter / Sine or Custom
<b>Load Type</b>	Resistive, Inductive
<b>Standards</b>	UL 508C
<b>Cooling</b>	Forced Air (fan optional)
<b>Markets</b>	Solar, Wind, UPS, Battery Storage, Motor Control, Power Conversion Applications.
<b>Current Sensors</b>	LEM – HASS 400-S
<b>IGBT Modules</b>	FUJI – Electric DualXT – 2MBI450VN-120 &-120S
<b>Gate Drive Boards</b>	AgileSwitch – AS2-EconoDual Electrical
<b>Interface Board</b>	AgileSwitch – ASI-PS
<b>Heat Sink</b>	Methode – High Performance Extruded

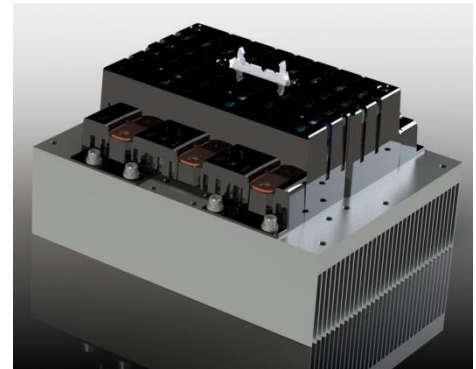

### SmartPower Stack Topology

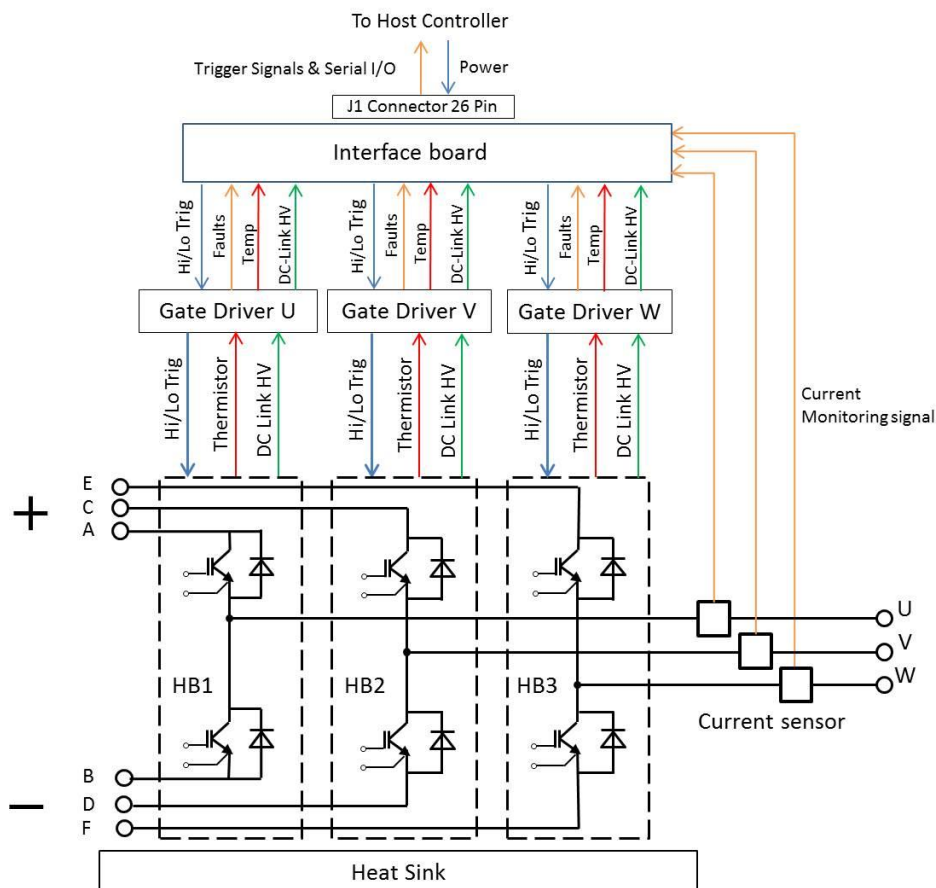

\*DC link capacitors and Controller Optional

<b>Prepared by:</b> Rob Weber	<b>Version:</b> v13.0
<b>Approved by:</b> Mike Stibgen	<b>Effective Date:</b> 09/03/2014

# SmartPower Stacks™ Spec Sheet

## Level 1: 100 kW DC-AC Inverter

### Note: Operating Conditions:

$V_{DC}=680$ ,  $V_{AC}=480$ ,  $F_{SW}=5\text{kHz}$ ,  $\cos(\varphi)=.9$ , airflow = 485 m<sup>3</sup>/hr, air temp = 25°C,  $I_{AC}=120 A_{RMS}$

### Electrical Characteristics

DC Link	Notes	Symbol	min	typ	max	unit
DC link Voltage	Continuous Operation	$V_{DC}$	280		900	V
Max Surge Voltage	2 min, non-operational				1200	V
Overvoltage Shutdown	Configurable		880	900	920	V

AC Data	Notes	Symbol	min	typ	max	unit
Voltage		$V_{AC}$			635	$V_{rms}$
Continuous Current	Per phase. See Typical Operating Conditions	$I_{AC}$		120	150	$A_{rms}$
Power Loss	See Typical Operating Conditions	$P_{loss}$		1800		W
Switching Freq <sup>1</sup>	See Typical Operating Conditions. Max frequency is @ 50°C	$F_{SW}$		5	10	kHz
Power Factor	Leading or Lagging	$\cos(\varphi)$	0		1	
Surge Current	Max for 10 $\mu$ s				900	$A_{rms}$

General Data	Notes	Symbol	min	typ	max	unit
High Voltage IGBT to Heat Sink				3.0		kV AC
High Voltage IGBT to J1 Connector				3.0		kV AC
High Voltage IGBT to J1 Connector – Creepage/Clearance			8.0			mm
High Voltage IGBT Connections and Circuits to Heat Sink			8.0			mm

### Heat Sink Air Cooled/Thermal Data

Data	Notes	Symbol	min	typ	max	unit
Airflow	See Typical Operating Conditions	$\Delta V/\Delta t_{Air}$		485		m <sup>3</sup> /hr
Air Pressure Drop		$\Delta P_{Air}$		410		Pa
Cooling Air Inlet Temperature	Typical Operating Conditions are supported over this operating range, including Tmax.	$T_{inlet}$	-25	25	50	°C

### Environmental Conditions

Data	Notes	Symbol	min	typ	max	unit
Storage Temp	Non-operational	$T_{stor}$	-40		85	°C
Maximum allowed heat sink temperature					90	°C
Ambient Temp Around IGBT Package	Continuous Operation	$T_{Amb}$	-25		50	°C
Altitude above sea level	Derated operation possible above Alt Max	Alt			1000	m
Air Pressure	Standard Atmosphere	$P_{air}$	900		1100	hPa
Humidity	Non-condensing	Rel. F	5		85	%
Pollution Degree				2		
Total Weight				13		kg
Weight w/o Heat Sink				7.6		kg
Dimensions	L x W x H		280	215	165	mm
Heat Sink Dimensions	L x W x H		280	215	80	mm
Torque at AC terminals		$M_{AC}$	16		20	Nm

Prepared by: Rob Weber

Version: v13.0

Approved by: Mike Stibgen

Effective Date: 09/03/2014

# SmartPower Stacks™ Spec Sheet

## Level 1: 100 kW DC-AC Inverter

### IGBT Module Data – Fuji 2MBI450VN-120 & -120S

Module Absolute Maximum Ratings	Notes	Symbol	min	typ	max	unit
Collector-Emitter Voltage		$V_{ces}$			1200	V
Gate-Emitter Voltage		$V_{ges}$			20	V
Collector Current	Continuous	$I_c$			450	A
Collector Current	Pulse 1ms	$I_{c\_pulse}$			900	A
Collector Power Dissipation	1 Device	$P_c$			2270	W
Junction Temperature	Maximum / Operating	$T_j$			175/150	°C
Isolation Voltage	Terminals to baseplate, 1 min	$V_{iso}$			2500	VAC

IGBT Data	Notes	Symbol	min	typ	max	unit
Collector-Emitter Saturation voltage	$I_c=300A, V_{ge}=15V, T_j = 150^\circ C$	$V_{ce\_sat}$		2.7		V
Parameter for linear model	$T_j = 25^\circ C$	$V_{ce1}$		1.0		V
Parameter for linear model	$T_j = 25^\circ C$	$R_{ce1}$		2.5		mΩ
Parameter for linear model	$T_j = 150^\circ C$	$V_{ce2}$		0.95		V
Parameter for linear model	$T_j = 150^\circ C$	$R_{ce2}$		3.9		mΩ
Thermal resistance junction to case		$R_{thjc}$			.094	K/W
Thermal resistance case to heat sink		$R_{thch}$			.0167	K/W

Diode Data	Notes	Symbol	min	typ	max	unit
Thermal resistance junction to case	For one device	$R_{thjc}$			.1	K/W
Thermal resistance case to heat sink	For one device	$R_{thch}$			.0167	K/W

Collector current vs. Collector-Emitter voltage (typ.)  
 $T_j = 25^\circ C / \text{chip}$

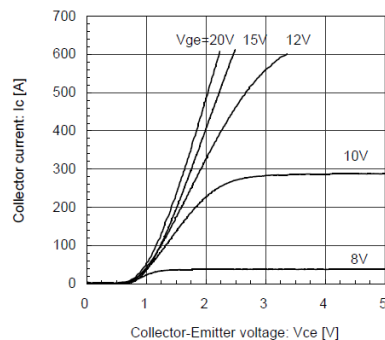

Collector current vs. Collector-Emitter voltage (typ.)  
 $T_j = 150^\circ C / \text{chip}$

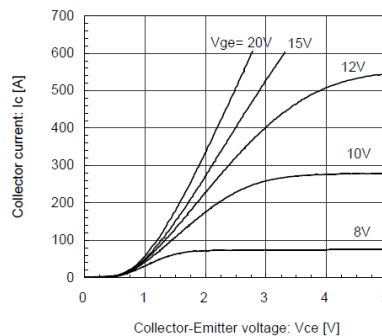

Switching loss vs. Collector current (typ.)  
 $V_{cc}=600, V_{ge}=\pm 15V, R_g=0.93\Omega, T_j=125^\circ C, 150^\circ C$

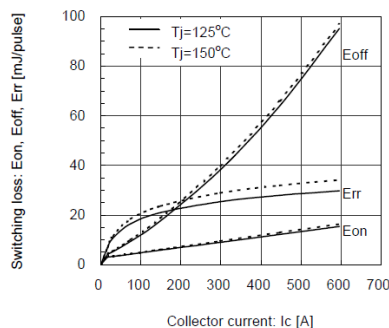

Forward Current vs. Forward Voltage (typ.)  
diode

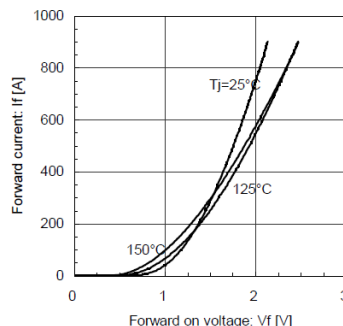

Prepared by: Rob Weber

Version: v13.0

Approved by: Mike Stibgen

Effective Date: 09/03/2014

# SmartPower Stacks™ Spec Sheet

## Level 1: 100 kW DC-AC Inverter

### External Input/Output Data

#### Input

##### DC Link Bus Connections A+, B-, C+, D-, E+, F-

There are 6 DC Link Bus Connections. These connections are positive and negative connections to the 3 Half Bridge (here by referred to as 'HB') sections in the SmartPower Stack.

Item	Description/Value
Bus Connections A+, C+, E+	Positive high voltage bus connections to HI Side collector of each HB
Bus Connections B-, D-, E-	Negative high voltage bus connections to LO Side emitters of each HB
Mounting Holes	M6x1 – 16 mm (Max)

#### Controller/Power to Interface Board – J1

Detailed connection data on previous page.

#### Output

##### Connections U, V, W

There are three output connectors. These connectors are located at the center point output of each HB.

Item	Description/Value
Bus Connections U, V, W	High Voltage DC Output
Mounting Holes	M8x1.2 – 25 mm (Max)

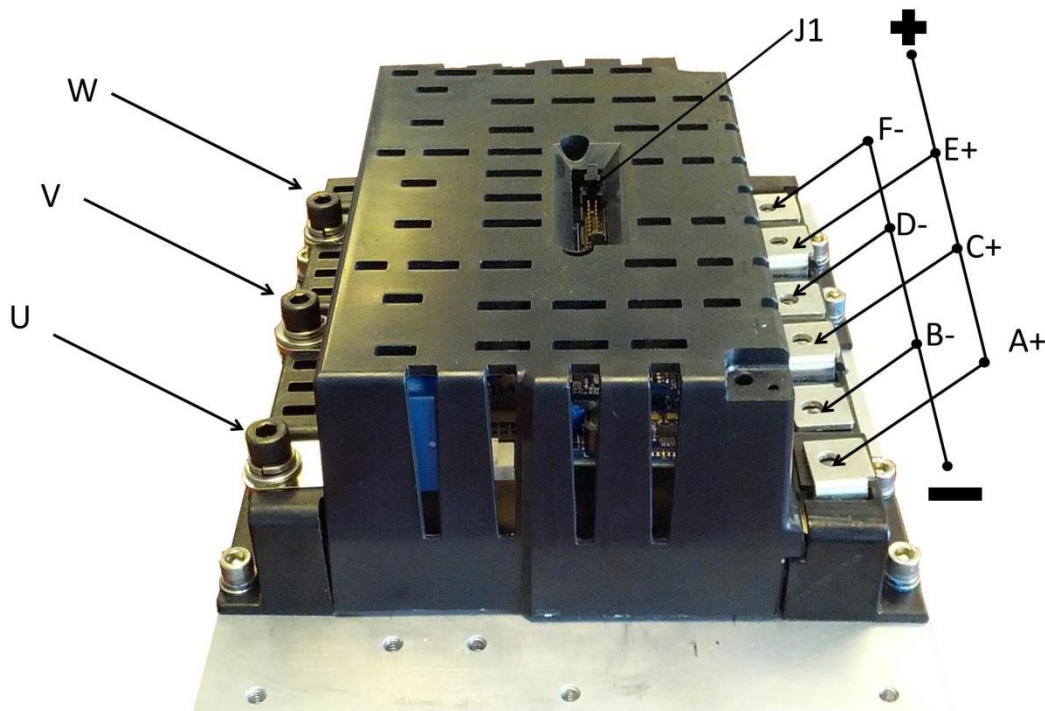

Prepared by: Rob Weber

Version: v13.0

Approved by: Mike Stibgen

Effective Date: 09/03/2014

# SmartPower Stacks™ Spec Sheet

## Level 1: 100 kW DC-AC Inverter

### Specification for Over Current Protection

For applications requiring fuse protection, the fuse should have the following characteristics:

Category	Notes	Value	Unit
Maximum Fuse Rating per Output AC Leg		200	A
Maximum Fuse Rating of DC Input		400	A
I <sup>2</sup> T Maximum		17.0	kA <sup>2</sup> s

### Controller Interface Data

Data	Notes	Symbol	min	typ	max	unit
Power Voltage Input		V <sub>in</sub>	13	24	30	V
Power Input <sup>(1)</sup>	V <sub>in</sub> = 24V	P <sub>aux</sub>			30	W
Driver board	See separate spec sheet for details	AS2-Econodual Electrical				
Input Signal Logic Hi Level	10kΩ to GND, 1nF to GND	V <sub>in_hi</sub>	11	15	17	V
Input Signal Logic Lo Level		V <sub>in_lo</sub>	-0.5	.5	2	V
Digital Output Level	Open collector, low=ok, max sink: 15mA	V <sub>out</sub>	0	-	30	V
Analog Output Format	0-10V, max source 15mA					
DC Voltage Measurement range	DC Voltage Corresponds to 0V to +12V analog range	V <sub>dc_range</sub>	100	-	1000	V
AC Current Measurement range		I <sub>ac_range</sub>	-900	-	+900	A
Temperature Measurement range	Current Output analog voltage is -12V to +12V Temperature output voltage i0V to +12V	T <sub>range</sub>	-40	-	150	°C

(1) The Current Input of the 24V supply should be current limited or fused to 3A.

### Controller/Power to Interface Board (J1) Connectors Data

#### J1 Connector PINOUT Descriptions

Pin No	Signal	Pin No	Signal
1	SHIELD	2	BOT-HB1-IN
3	ERROR-HB1-OUT	4	TOP-HB1-IN
5	BOT-HB2-IN	6	ERROR-HB2-OUT
7	TOP-HB2-IN	8	BOT-HB3-IN
9	ERROR-HB3-OUT	10	TOP-HB3-IN
11	OVERTEMP-OUT	12	RESERVED, MUST LEAVE NC
13	VDC-LINK	14	VCC – +24V Supply Voltage
15	VCC – +24V Supply Voltage	16	+15V
17	+15V	18	GND
19	GND	20	TEMP-SENSE-OUT
21	Aux GND	22	I-SENSE1-OUT
23	Aux GND	24	I-SENSE2-OUT
25	Aux GND	26	I-SENSE3-OUT

#### J1 Connector Hardware

Connector	Type	Manufacturer Part Number
Ribbon Cable	26 Pins	TE Connectivity 1658622-6
Interface Board	26 Pins	TE Connectivity 5499923-6

Prepared by: Rob Weber

Version: v13.0

Approved by: Mike Stibgen

Effective Date: 09/03/2014

# SmartPower Stacks™ Spec Sheet

## Level 1: 100 kW DC-AC Inverter

### Temperature, Voltage and Current Monitor Output

AgileSwitch SmartPower Stacks implement five analog output signals available on J1, on the 26 pin output connector.

#### Temperature (TEMP-SENSE-OUT PIN 20)

The temperature monitor signal is an analog output voltage with a 0V to 11V range that represents the temperature of the IGBT thermistor in the center IGBT half bridge (HB) leg in the SmartPower Stack. The graph below shows the temperature and output voltage relationship. Frequency response = 100Hz

**Note:** A reading of 10V corresponding to a 110 °C thermistor temperature will generate a fault and shutdown condition.

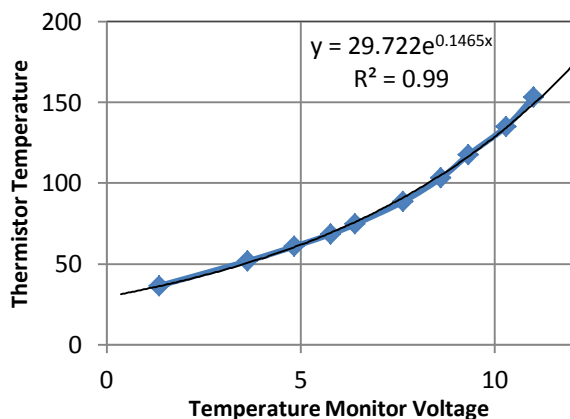

#### High Voltage (HV) Link (VDC-LINK PIN 13)

The HV monitor is an analog voltage with a range of 0 to 10V. The output voltage represents the voltage on the high side connection of the SmartPower Stack. High Voltage is calculated by the following approximate equation:

$$V_{DC\ LINK} = (102 \times HV_{MONITOR}) + 5V$$

The DC Link Monitor has an accuracy of  $\pm 1\%$  from 100V to 950V. The chart demonstrates the relationship between analog output and HV Link Monitor Output Voltage. Frequency response = 1KHz

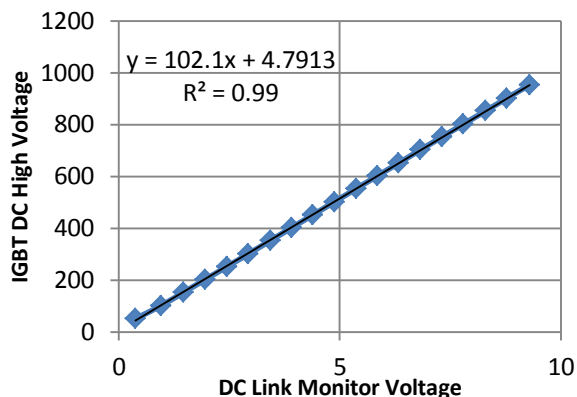

#### Current (I-SENSE-OUT PINS 22, 24, 26)

The SmartPower Stack has three current monitor signals available for the 3 phase (3 HB) configuration. Each output is an analog voltage with a voltage range of  $\pm 12V$ . The output voltage is a linear representation of the current through each leg. The actual current for each phase is calculated by the equation below where  $i_{sv}$  stands for sense voltage and  $x$  equals 1, 2, or 3 depending on the leg of interest.

$$i_{phase} = 75 \times i_{sv}(x)$$

**Note:** The accuracy of the current sensor is  $\pm 1.5\%$ . Note that each current sensor has an offset current error of  $\pm 3A$  that should be nulled in the system's monitoring software. Frequency response = 10KHz

A current monitor voltage of  $\pm 10V$  will generate a fault and shutdown condition.

Prepared by: Rob Weber

Version: v13.0

Approved by: Mike Stibgen

Effective Date: 09/03/2014

# SmartPower Stacks™ Spec Sheet

## Level 1: 100 kW DC-AC Inverter

### Protection / Faults

#### Fault Table

Fault Condition/Action	Generic Sample Default Trigger Values	Action on IGBT if Active
Desat - HI	>7 Volts for 6.1 $\mu$ s*	Turn off HI side
Desat - LO	>7 Volts 6.1 $\mu$ s*	Turn off LO side
HV Overshoot - HI	Not Applicable*	Active Clamping occurs
HV Overshoot - LO	Not Applicable*	Active Clamping occurs
UVLO - HI	<12 Volts	Turn off HI side
UVLO - LO	<12 Volts	Turn off LO side
Cross Latch/Shoot Through	Attempt to turn on both IGBTs simultaneously	Does not allow turn on of inactive IGBT until active is off for 2 $\mu$ s*
DC Link Overvoltage	900 Volts*	Shut down all IGBTs
Overcurrent	750A	Shut down all IGBTs
Over Temperature	>110°C	Shut down all IGBTs

Certain parameters are configurable (noted by \*).

#### Fault Reporting Pins (Configurable)

Fault Condition/Action	Pin 3	Pin 6	Pin 9	Pin 11
DSAT HB1	X			
DSAT HB2		X		
DSAT HB3			X	
OVERCURRENT HB1	X	X	X	
OVERCURRENT HB2	X	X	X	
OVERCURRENT HB3	X	X	X	
TEMP	X	X	X	X
DC LINK OV	X	X	X	
UVLO	X	X	X	

"X" = possible to map this fault to this pin

Note: only 1 fault may be mapped to each pin,

Prepared by: Rob Weber

Version: v13.0

Approved by: Mike Stibgen

Effective Date: 09/03/2014

# SmartPower Stacks™ Spec Sheet

## Level 1: 100 kW DC-AC Inverter

### SmartPower Stack™ Components

 AgileSwitch Interface Board

 AgileSwitch Gate Drivers

 Fuji IGBTs

LEM Current Sensor

 Methode Heat Sink

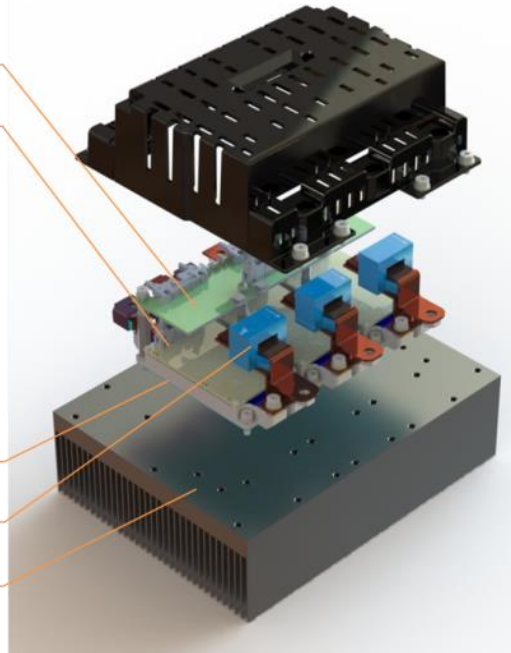

### Mechanical Dimensions

Units:  
[mm]  
inches

[215]  
8.5

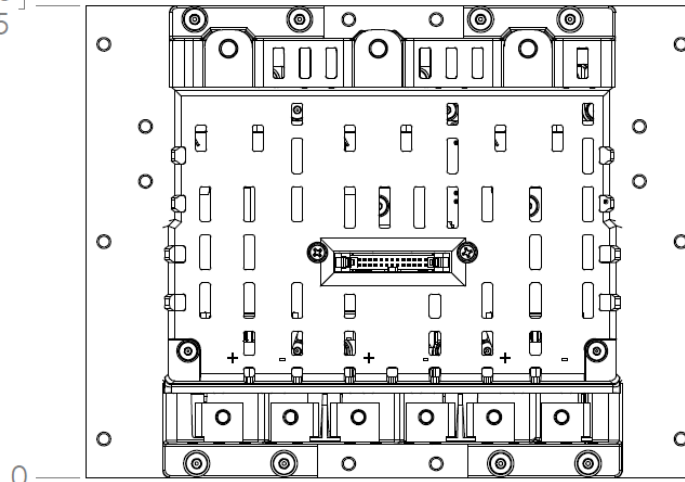

[156]  
6.1

[80]  
3.1

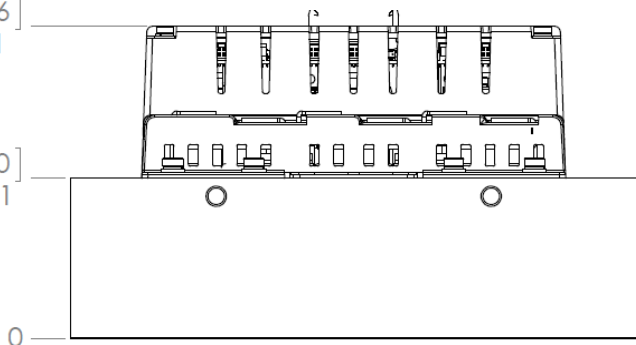

[280]  
11.0

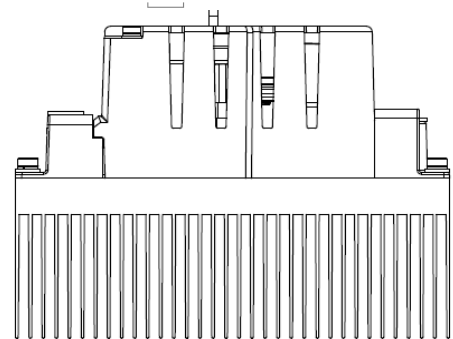

Prepared by: Rob Weber

Version: v13.0

Approved by: Mike Stibgen

Effective Date: 09/03/2014



# SmartPower Stacks™ Spec Sheet

## Level 1: 100 kW DC-AC Inverter

### SmartPower Stack™ Consortium

The SmartPower Stack Consortium consists of global leaders in controllers, IGBTs, gate drives, capacitors, bus bar architectures and cooling solutions that have joined to create the industry's first fully integrated, deployment-ready commercial embedded system for high-volume solar, photovoltaic, wind, hybrid electric and electric vehicles, as well as high capacity uninterruptible power supply and efficient motor drive applications.

As part of this effort, National Instruments supplies the controller, I/O, simulation and programming toolset, SBE provides new high performance wound film capacitors, Fuji supplies industry leading IGBTs, AgileSwitch offers leading edge IGBT gate drives and Methode offers state-of-the-art bus bar architectures, thermal management solutions, assembly and test capability.

Together, the five companies are creating fully integrated sub-system solutions for the power electronics industry with the highest performance for energy conversion inverters and convertor systems. This effort represents the industry's first collaboration of best-in-class technologies that are tightly integrated to deliver smart, efficient, reliable and long lasting power conversion.



7401 West Wilson Avenue  
Chicago, IL 60706-4548  
[www.methode.com](http://www.methode.com)  
[mstibgen@methode.com](mailto:mstibgen@methode.com)



1650 Arch Street, #1905  
Philadelphia, PA 19103  
[www.AgileSwitch.com](http://www.AgileSwitch.com)  
[info@AgileSwitch.com](mailto:info@AgileSwitch.com)



11500 North Mopac Expressway  
Austin, TX 78759  
[www.ni.com](http://www.ni.com)  
[brian.maccleery@ni.com](mailto:brian.maccleery@ni.com)



81 Parker Road  
Barre, VT 05641-9106  
[www.sbelectronics.com](http://www.sbelectronics.com)



50 Northfield Avenue  
Edison, NJ 08837  
[www.americas.fujielectric.com](http://www.americas.fujielectric.com)

### Legal Disclaimer

AGILESWITCH and the AGILESWITCH logo are trademarks or registered trademarks of AGILESWITCH, LLC in various countries. Fuji is trademark of FUJI ELECTRIC CO. Ltd. Methode is trademark of Methode Electronics, INC. SBE and Power Ring Film Capacitors are trademarks of SBE. National Instruments is trademark of National Instruments. SmartPower Stack is trademark of the SmartPower Stack Consortium. Any other names are the property of their respective owners.

Information in this document supersedes and replaces all information previously supplied.

Specifications are subject to change without notice.

© 2010-2014 - All rights reserved.

Prepared by: Rob Weber	Version: v13.0
Approved by: Mike Stibgen	Effective Date: 09/03/2014